

1160 eHoftrac

Hoftrac



WEIDEMANN
designed for work



1160 eHoftrac Technical specifications

Engine data

Electric motor

Travel drive motor, rating S2 (60 minutes)	6.5 kW
Hoist motor, rating S3 (15 %)	8.5 kW

Battery Standard

Battery voltage	48 V
Rated capacity K5	230 Ah
Battery weight (± 5 %)	394 kg
Charging time	6 h
Running time under long-time application with heavy materials handling, uninterrupted operation	1.5* h
Running time under agricultural activities, uninterrupted operation	2 - 3.5* h

Running time under normal agricultural activities with interruptions (30 min. driving time, 30 min. standstill)	to 4* h
Battery Optional	
Battery voltage	48 V
Rated capacity K5	310 Ah
Battery weight ($\pm 5\%$)	450 kg
Charging time	8 h
Running time under long-time application with heavy materials handling, uninterrupted operation	2.1* h
Running time under agricultural activities, uninterrupted operation	2.8 - 4.5* h
Running time under normal agricultural activities with interruptions (30 min. driving time, 30 min. standstill)	to 5* h
Electrical system	
Operating voltage	12 V
Weights	
Operating weight (standard)	2350 kg
Tipping load with bucket - machine straight	1348 kg
Tipping load with bucket - machine articulated	1251 kg
Tipping load with pallet fork - machine straight	1089 kg
Tipping load with pallet fork - machine articulated	916 kg
Vehicle data	
Axle	T80
Cab (optional)	FSD (eps, epsPlus)
Ground speed	0 - 15 km/h
Speed stages	1
Hydraulic oil tank capacity	18.5 l
Hydraulic system	
Steering hydraulics - Oil flow	32 l/min
Steering hydraulics - Operating pressure	225 bar
Drive	
Type of drive	electrical
Traction drive	Universal joint shaft
Noise values	
Average sound power level L _{wA}	91.8 dB(A)
Guaranteed sound power level L _{wA}	92 dB(A)
Specified sound pressure level L _{pA}	76 dB(A)

The running times of the battery are strongly dependent on the respective application conditions, the work task and the manner of driving. This can also mean that a longer running time can also be achieved. The specified running times can also be fallen short of in extreme cases. An uninterrupted operation (e.g. 30 minutes of driving, 30 minutes of standstill) extends the running time of the battery.

Tipping load calculation according to ISO 14397

FSD = operator's canopy eps = Easy

Vibrations (weighted average effective value)

Hand-arm vibrations (HAV): The hand-arm vibrations are no more than 2.5 m/s²

Whole body vibrations: This machine is equipped with a driver's seat that meets the requirements of EN ISO 7096:2000.

When the loader is properly used, the whole body vibrations vary from below 0.5 m/s² up to a short-term maximum value.

It is recommended to use the values specified in the table when calculating the vibration values according to ISO/TR 25398:2006. At the same time the actual use conditions have to be taken into consideration.

Telescopic loaders, like wheel loaders, are to be classified by operating weight.

Type of loader	Typical operating conditions	Average value			Standard deviation (s)		
		1.4*a _{w,eqx}	1.4*a _{w,eqy}	a _{w,eqz}	1.4*s _x	1.4*s _y	s _z
		[m/s ²]	[m/s ²]	[m/s ²]	[m/s ²]	[m/s ²]	[m/s ²]
Compact wheel loader (operating weight < 4,500 kg)	Load & carry (load and transport work)	0.94	0.86	0.65	0.27	0.29	0.13
Wheel loader (operating weight > 4,500 kg)	Load & carry (load and transport work)	0.84	0.81	0.52	0.23	0.2	0.14
	Application in extraction (harsh application conditions)	1.27	0.97	0.81	0.47	0.31	0.47
	Transfer drive	0.76	0.91	0.49	0.33	0.35	0.17
	V-operation	0.99	0.84	0.54	0.29	0.32	0.14

1160 eHoftrac
Hoftrac

1160 eHoftrac Dimensions

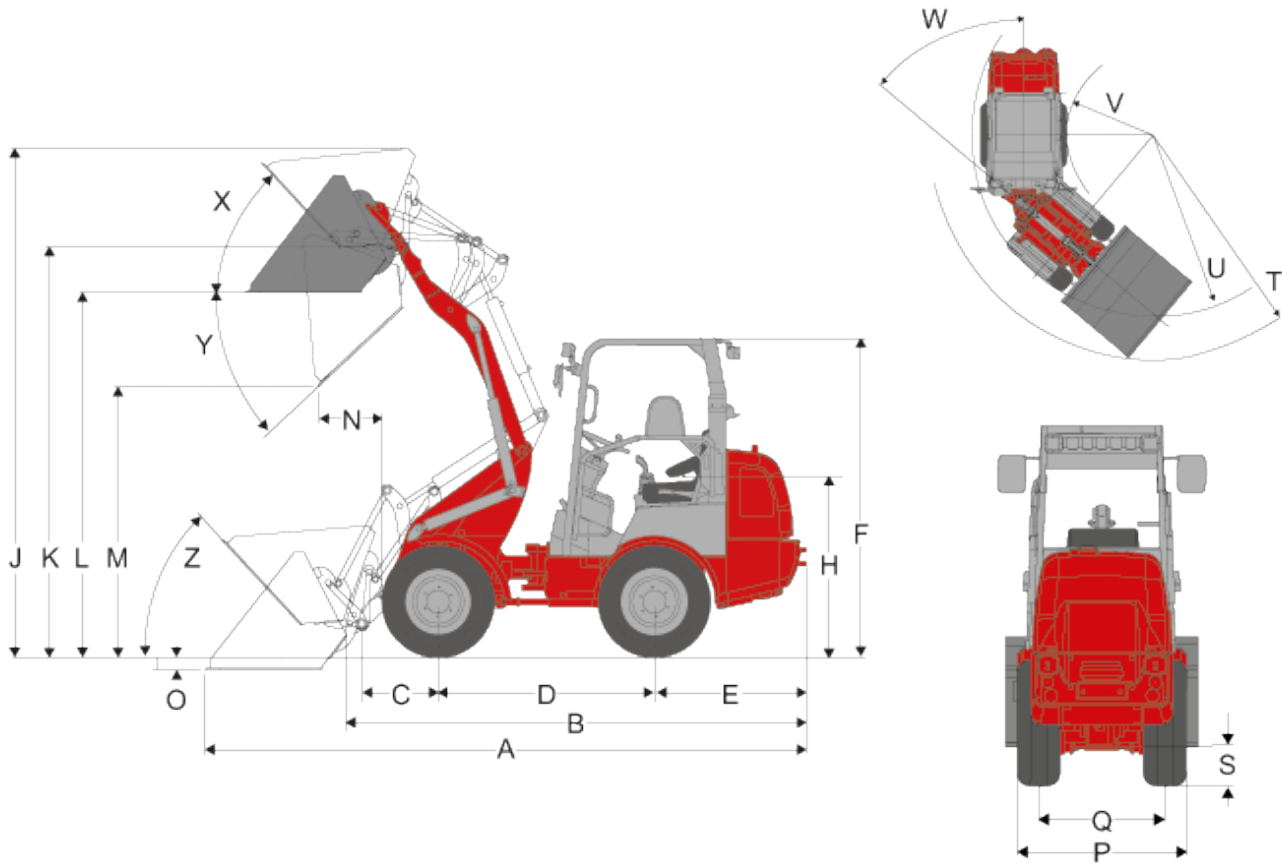

A	Total length	3,983 mm
B	Total length (without bucket)	3,005 mm
C	Axle middle to bucket pivot pin	508 mm
D	Wheelbase	1,468 mm
E	Rear overhang	917 mm
F	Height to top of overhead guard fixed	2,257 mm
	Height to top of overhead guard foldable (eps)	2,361 mm
	Height to top of overhead guard foldable, folded (eps)	1,948 mm
H	Seat top height	1,293 mm
J	Total working height	3,443 mm
K	Height of bucket pivot (max.)	2,760 mm
L	Load-over height	2,441 mm
M	Dumping height	1,819 mm
N	Operating distance for M	498 mm
O	Digging depth	77 mm
P	Total width	1,044 mm
Q	Track width	780 mm

S	Ground clearance	255 mm
T	Maximum radius external	2,592 mm
U	Radius at the outer edge	2,138 mm
V	Inside turning radius	1,017 mm
W	Inclination angle	50 °
X	Rollback angle at max. lifting height	50 °
Y	Dumping angle (max.)	40 °
Z	Rollback angle (on the ground)	49 °

1160 eHoftrac

Hoftrac

1160 eHoftrac Standard components

Electric motor drive

- 6.5 kW

Electric motor working hydraulics

- 9 kW

Drive system

- Compact axle T80
- Electric drive system, travel direction can be selected via joystick
- Active standstill regulation, the vehicle is held by the engine
- Hill-hold function: In the event of a standstill on a hill, the electric motor holds the machine
- Tires 10.0 / 75 - 15.3 AS ET10

Steering system

- Hydraulic articulated pendulum steering, 12° oscillating angle

Hydraulics

- 3rd Control circuit front DN10
- Lock for steering valve

Driver's Cabin

- Canopy with retaining system ROPS / FOPS tested
- Comfort seat with safety belt, fully suspended, weight, back and horizontal adjustment, 60 mm spring deflection
- Joystick with travel direction switch

Other

- Working lights (2 front, 1 rear)
- Operating hour meter
- Battery charge indicator
- Mechanical quick-change system for attachments

1160 eHoftrac

Hoftrac

1160 eHoftrac Options

A battery must be chosen for the 1160 eHoftrac:

- Battery 48V 240 Ah
- Battery 48V 300 Ah

Battery charger for battery

- Battery charger 400 V / 65 A for battery 48V 240 Ah
- Battery charger 400 V / 120 A for battery 48V 300 Ah

Driver's Cabin

- Right armrest
- eps (Easy Protection System) - fold-down operator's canopy
- Adjustable steering column
- Air-cushioned comfort seat (fabric / artificial leather)
- Heated seat
- Wheel spacer (+30mm)

Lighting

- LED work lights, 2 front, 1 rear
- Lighting according to Road Traffic Regulations
- Rotary beacon

Hydraulics

- Unpressurised reverse travel (front)
- 3rd comfort control circuit
- 4th comfort control circuit
- Faster plug-in connector (machine or attachment side)
- Notch for joystick (single)
- Additional hydraulic connection in rear (dual acting)

Electrical connections

- Plug receptacle in front, 3 or 7-pin (single or dual function)

Other

- High lifting height
- Hydraulic quick-change system for attachments
- Reversing warning system
- Self-recovery coupling
- Hand lever grease gun
- Combination case with warning triangle and first-aid kit
- Switch position indicator
- Tool box
- Tool kit
- custom made paint finish
- Technical Inspection Authority expert's report
- Registration plate mounting

Please note: that product availability can vary from country to country. It is possible that information / products may not be available in your country. More detailed information on engine power can be found in the operator's manual; the stated power may vary due to specific operating conditions. Subject to alterations and errors excepted. Applicable also to illustrations.

Copyright © 2021 Weidemann GmbH.